

**MICRO CARE**

**SOLAR COMPONENTS**



**MICROCARE  
3 PHASE  
INVERTER  
MANUAL**

**MICRO CARE**

# Contents

1. INTRODUCTION .....	4
2. SAFETY INSTRUCTION .....	5
3. SYSTEM DESCRIPTION .....	7
4. WIRING DIAGRAM .....	10
5. INVERTER OPERATION .....	11
6. INVERTER CLUSTER PROGRAMMING ....	14
7. CLUSTER SETUP .....	18

**Please be aware that this manual is only for 3 Phase Cluster Setup support. For further information referring to the Bi-Directional Inverter please refer to the Microcare Inverter Manual.**

### **IMPORTANT NOTIFICATION**

**If the inverters are connected in 3 Phase configuration and connected to either generator or grid, then the phase rotation must be checked and confirmed.**

**Only Right Phase rotation is supported.**

**If the Phase rotation is incorrect the inverter will be damaged.**

# **1. INTRODUCTION**

## **1.1 General Description**

The Microcare Pure Sine Wave Inverter delivers clean true sine wave output power. Applicable for any kind of load such as home appliances, consumer electronics and office equipment. This series features a durable and continuous 24 hour operation. The compact and modular design makes utility interactive installations easier and more cost effective. It is a high quality product that offers the best price/performance ratio in the industry.

## **1.2 Key Features**

1. Multiple microprocessor design base.
2. Compatible with both linear and non-linear load.
3. 24 hours operation on the inverter.
4. DC start and automatic self-diagnostic function.
5. THD less than 3%.
6. High efficiency design to save electricity.
7. Low heat dissipation in long time operation.
8. Design to operate under harsh environment.
9. Wall Mounted.

## **1.3 Important Notices**

- Read instructions carefully before operating Inverter.
- Inverter connection instructions must be followed.
- The unit should only be opened by skilled personal.
- Retain the load within the rating of Inverter to prevent faults.
- Keep the Inverter clean and dry.
- For 3 Phase Inverters, Battery Charging is not supported, Only an MPPT regulator for solar charging is allowed.

## **2. SAFETY INSTRUCTION**

### **2.1 Positioning**

- 2.1.1 Do not put the Inverter on rugged or inclined surfaces.
- 2.1.2 Do not install the Inverter near water or in damp environments.
- 2.1.3 Do not install the inverter where it would be exposed to direct sunlight or near a heat source.
- 2.1.4 Do not block the ventilation openings in the inverter housing and don't leave objects on top of the inverter.
- 2.1.5 Keep the inverter far away from heat emitting sources.
- 2.1.6 Do not expose the inverter to corrosive gases.
- 2.1.7 Install Inverter in an ambient temperature setting of: 0°C - 40°C.

### **2.2 Installation.**

**MOUNT THE SINGLE HANGING BRACKET ONTO THE WALL.  
SLIDE THE INVERTER OVER THE BRACKET SO THE INVERTER HANGS FROM THE BRACKET.**

- 2.2.1 Connect the Inverter AC OUTPUT only to an earthed DB Panel.
- 2.2.2 The AC connections are located at the top of the inverter under the top side cover. (Where the Live and N In, Live and N Out and Earth Connections are.)
- 2.2.3 If a 220 vac supply or a generator is available connect into the Live In and Neutral.
- 2.2.4 Make sure the BATTERY INPUT CIRCUIT BREAKER is OFF.
- 2.2.5 Place cables in such a way that no one can step on or trip over them.
- 2.2.6 Battery Cables must be a minimum size of 35mm<sup>2</sup> and short as possible.
- 2.2.7 The battery cables come out of the bottom of the unit next to the input circuit breaker.
- 2.2.8 The unit must be mounted in a vertical position against the wall.

### **2.3 Earthing of Equipment.**

Equipment surge protection products are an effective way of controlling dangerous surges that can enter a facility. When strategically placed and correctly installed, the Surge Protectors will effectively reduce harmful over voltage conditions that can damage electrical and electronic equipment.

It is important that the protection system includes both structural and surge protection equipment.

When lightning current passes into the ground through a conductor (eg. Tree Trunk) a powerful electromagnetic force is set up due to the fast rise times of the strike. This electromagnetic force then couples into any inductive loops that may be available in nearby buildings. When these currents equalize, damage usually occurs to the equipment.

## Lightning Protection Zones

LPZ0A:	This zone is an area where a direct hit to the structure is possible. The current may rise to a value of 200,000A (10/350 $\mu$ s) producing extremely high electromagnetic fields. Any conductor system must be capable of carrying the full lightning current.
LPZ0B:	This zone is an area where a direct hit is not possible, but high electromagnetic fields will be present. This zone is determined by the effectiveness of the structural protection system.
LPZ1:	Again, a direct hit in this area is not possible due to the screening measures applied. The electromagnetic field is much lower than LPZ0A and LPZ0B. It is in this zone where appropriate surge arresters may be fitted that will limit the value of surge current entering a facility.
LPZ2:	The value of surge current and electromagnetic field will be lower than that of LPZ1 when correct protection principles have been applied. It is in this area where sensitive electronic equipment may be safely installed.

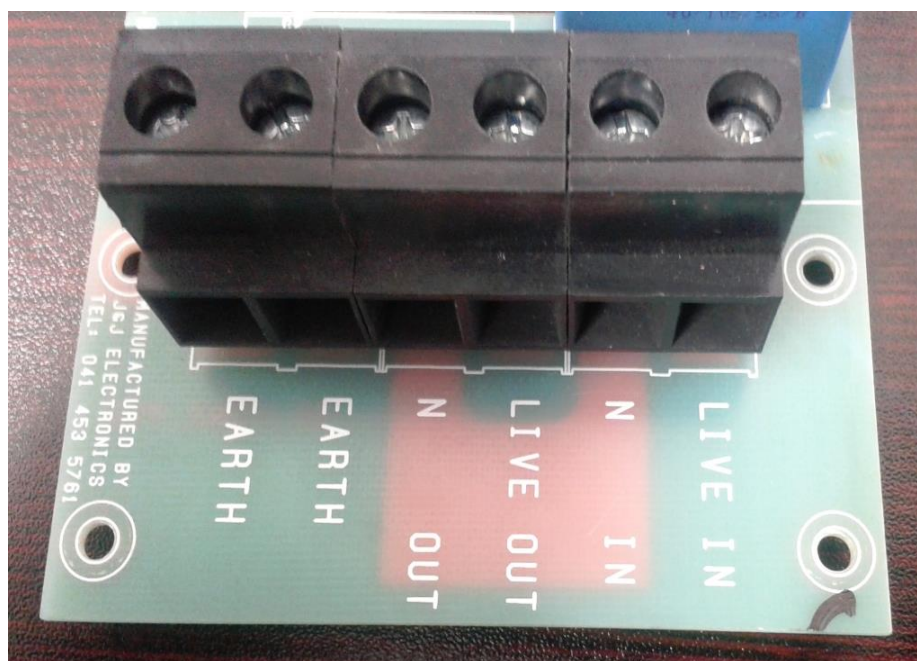

- |    |                    |   |                             |
|----|--------------------|---|-----------------------------|
| 1. | LIVE IN and N IN   | – | Connect to Grid             |
| 2. | LIVE OUT and N OUT | – | Connect to AC Load.         |
| 3. | EARTH 1            | – | Connected to Earth Bar.     |
| 4. | EARTH 2            | – | Connected to Chassis Earth. |

- Neutral IN** – **Make sure the Neutral IN Connection for all Units is common.**  
**Neutral OUT** – **Make sure the Neutral OUT Connection for all Units is common.**

If the Inverter is connected as a stand-alone inverter with no Mains Connection, The Neutral is required to be earthed using an earth spike.

**If the Inverter is not earthed; warranty will be null and void.**

## 2.4 Maintenance and Service

2.4.1 Caution – Risk of Electric Shock.

2.4.2 Batteries may cause electric shock and have high short-circuit current. Please take the precautionary measures specified below and any other measures necessary when working with batteries.

- Remove wristwatches, rings and other metal objects.
- Use only tools with insulated grips and handles.

### 3. SYSTEM DESCRIPTION

#### 3.1 System Description. (1Kw;2Kw;3Kw and 5Kw Unit)

##### 3.1.1 System Front View. (1Kw – 5Kw Unit)

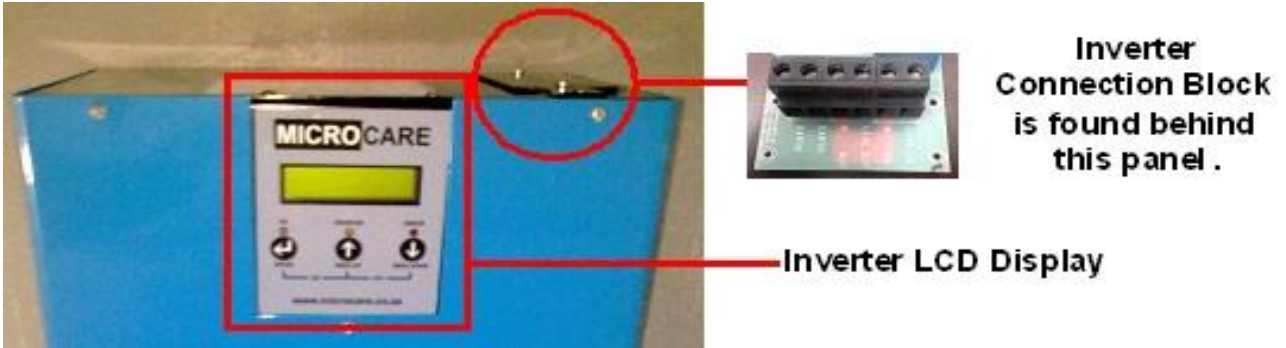

##### 3.1.2 System Back View. (1Kw – 5Kw Unit)

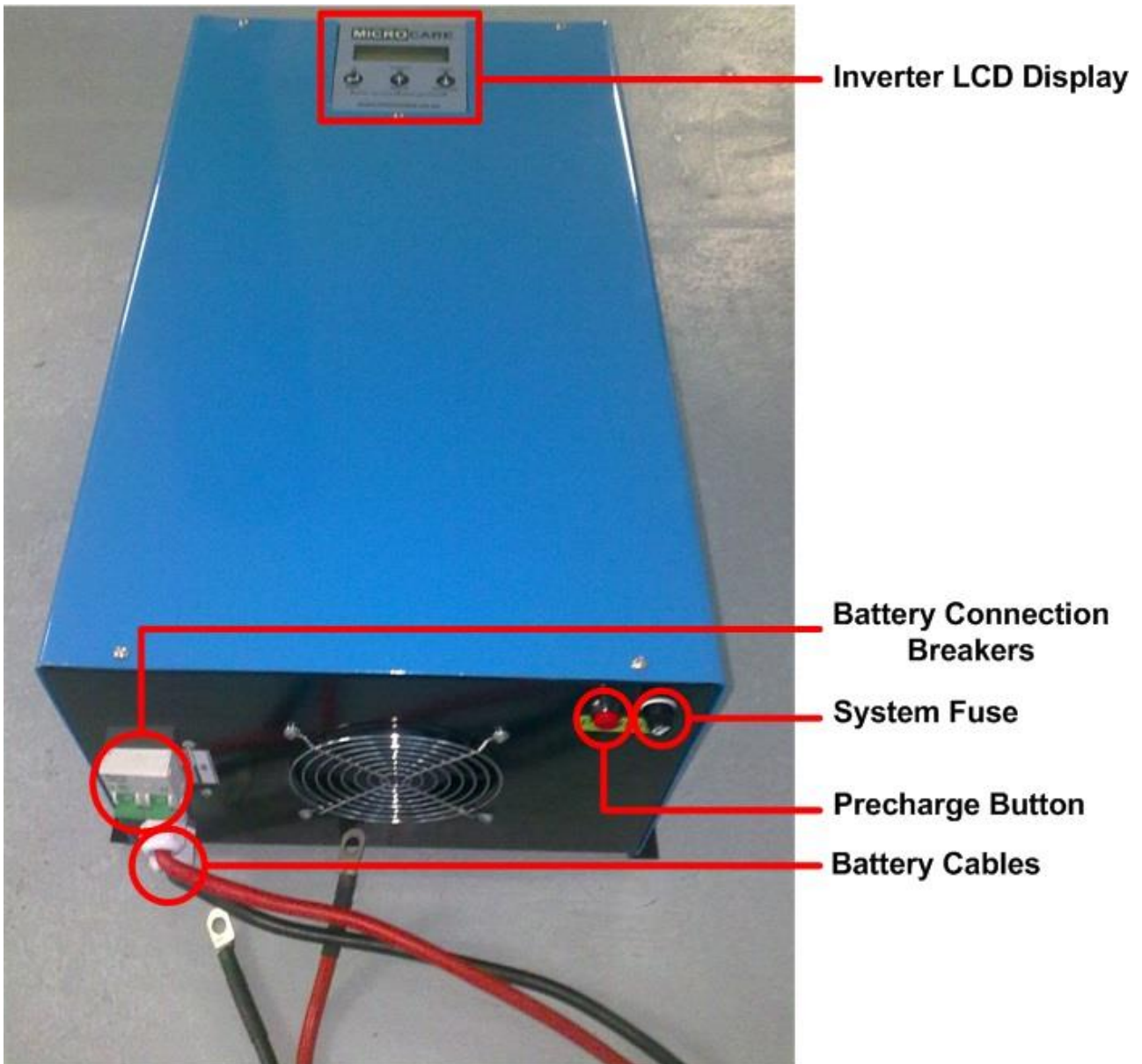

#### 3.2 System Description. (10Kw and 12Kw)

3.2.1 System Front View. (10Kw – 12Kw Unit)



Inverter LCD Display

3.2.2 System Left View. (10Kw – 12Kw Unit)

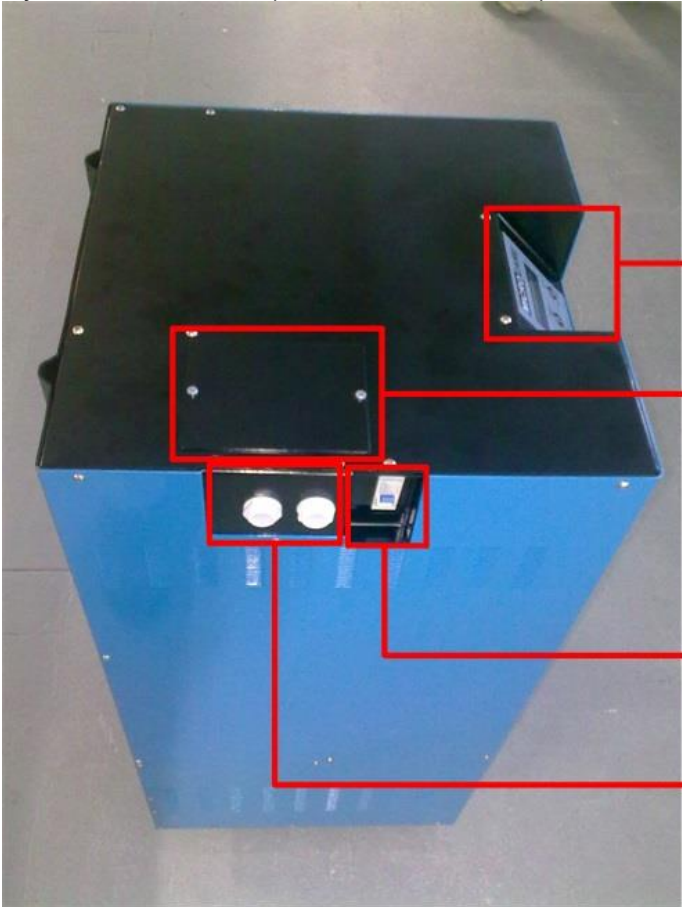

Inverter LCD Display



Inverter Connection Block is found behind this panel.

AC LOAD Breaker

LIVE IN & OUT  
NEUTRAL IN & OUT  
Cables come out here.



### 3.2.3 System Right View. (10Kw – 12Kw Unit)

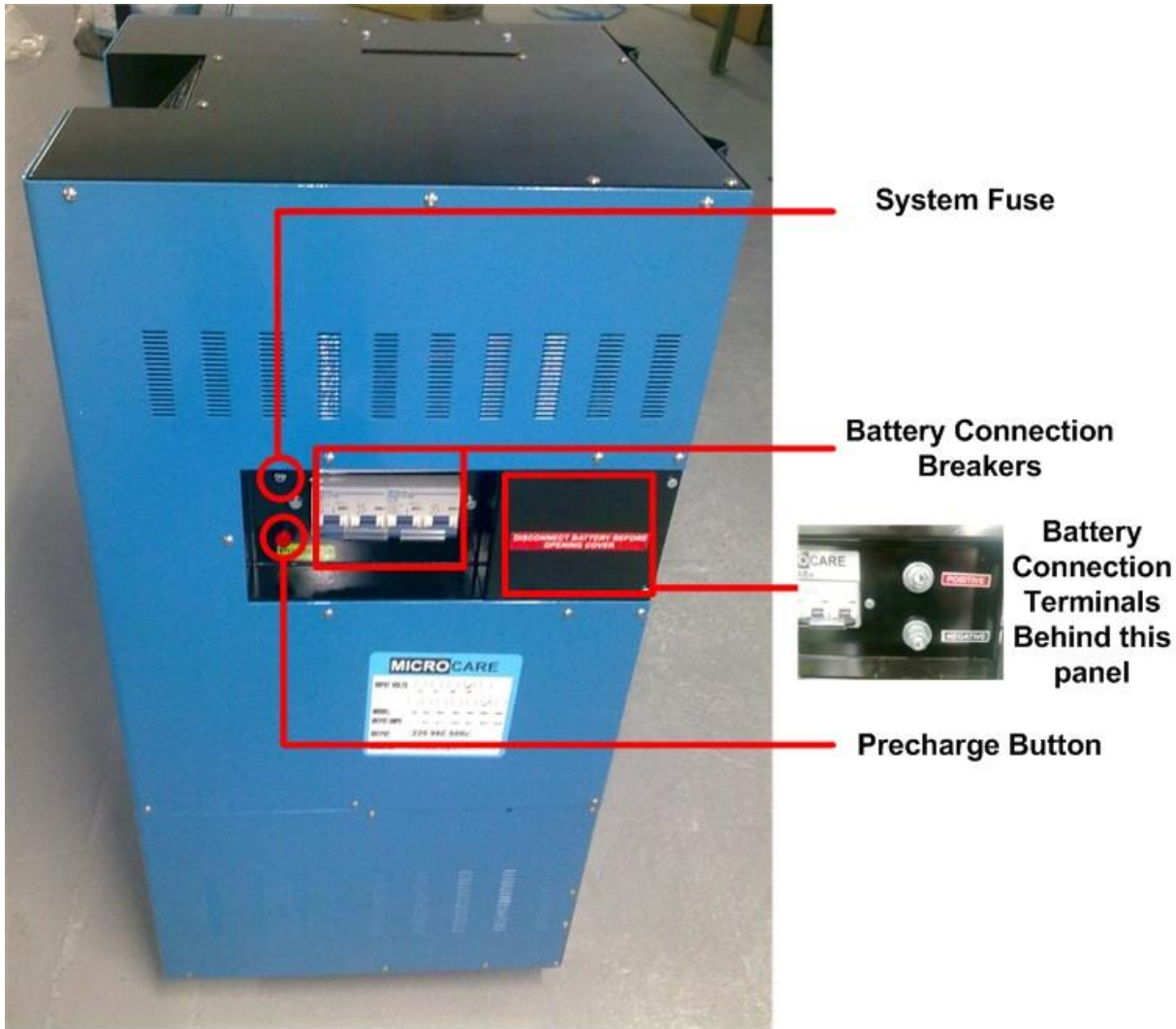

### 3.3 Front Panel Description for LCD Model.

- 3.3.1 LCD Display: This indicates the UPS's operational information, including output voltage, battery voltage, output load and inside temperature.
- 3.3.2 UP-Key: Use to move the display up.
- 3.3.3 DOWN-Key: Use to move the display down.
- 3.3.4 ENTER-Key: It is pressed with the UP-Key to turn on the UPS. Push the ENTER button to confirm or store DATA.
- 3.3.5 Push the UP and DOWN keys together to turn off the inverter.
- 3.3.6 Fault LED (Red): To indicate the INVERTER is in a fault condition because of inverter shutdown or over temperature.
- 3.3.7 Warning LED (Yellow): To indicate the INVERTER is in the status of overload or battery LOW.
- 3.3.8 Normal LED (Green): To indicate the INVERTER is operating normally.

### 3.4 Outline Description

Wall mount unit.

#### 4. WIRING DIAGRAM

- 4.1. Wire the inverters as Displayed in the Diagram Below.  
Do not turn on the Grid Breaker or any Load to the output of the Inverter until steps 4 – 7 have been completed.

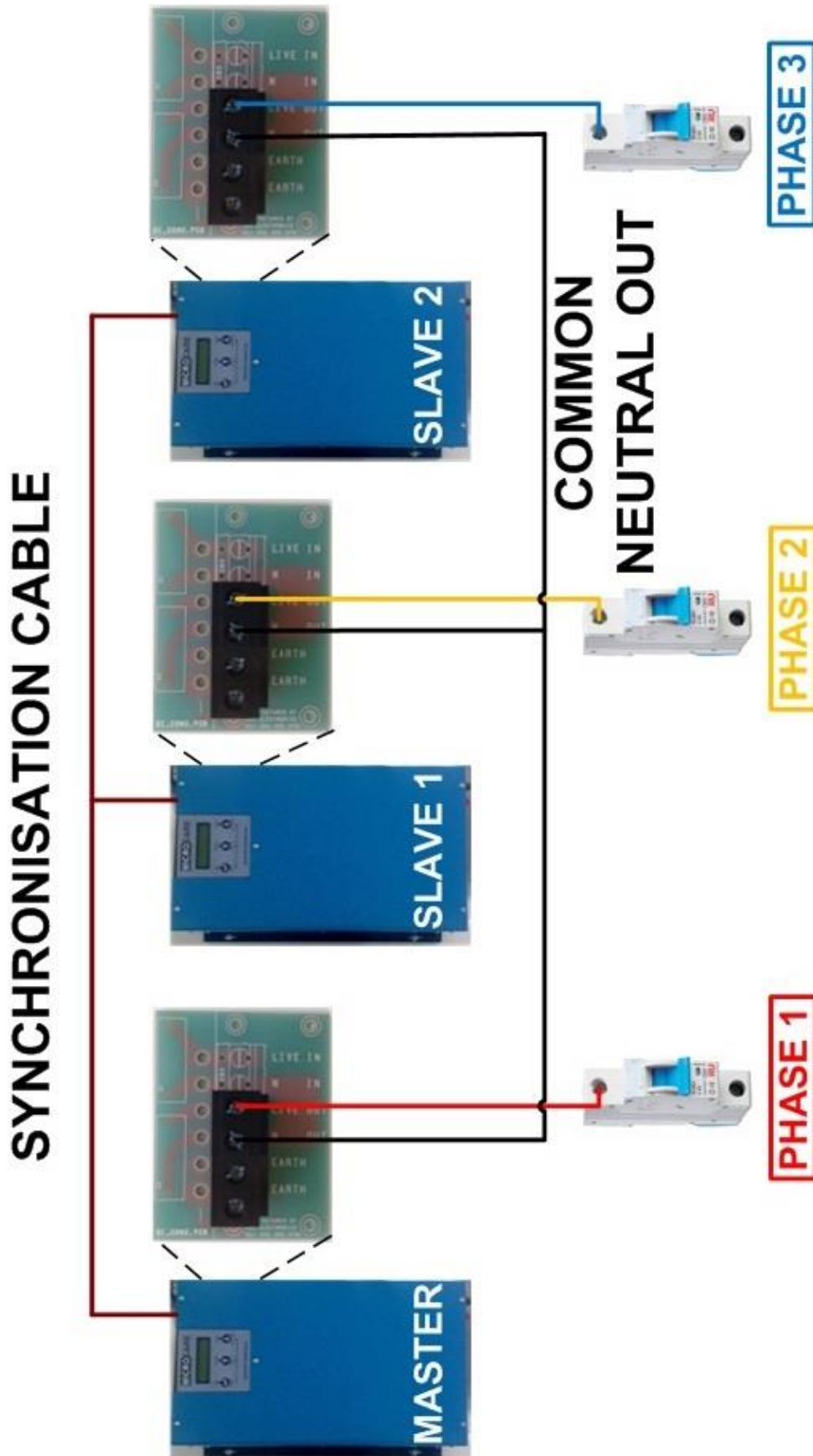

## 5. INVERTER OPERATION

### 5.1 Check Prior to Start Up

- 5.1.1 Ensure the Inverter is mounted vertically.
- 5.1.2 Check input and output cables are correctly secured.
- 5.1.3 Check if Battery voltage meets the Inverter Rating.
- 5.1.4 Ensure that no output load is connected to any of the inverters.
- 5.1.5 Ensure the Cluster Communication Cables are plugged in to the Inverters.

### 5.2 Operation Procedure

Please follow the instructions below for the INVERTER operation.

### 5.3 Power Up Procedure

- 5.3.1 Power Up MASTER PHASE 1 Inverter First.

**Wait for Inverter to finish Calibration and state that the UPS is Turned Off.**

- 5.3.2 Power Up SLAVE PHASE 2 Inverter Second.

- 5.3.3 Power Up SLAVE PHASE 3 Inverter Last.

### 5.4 Do the Following for all of the 3 Phase Inverters to Start the Inverters:

Push and hold the **RED PRECHARGE BUTTON** until the Display comes on and shows the following:

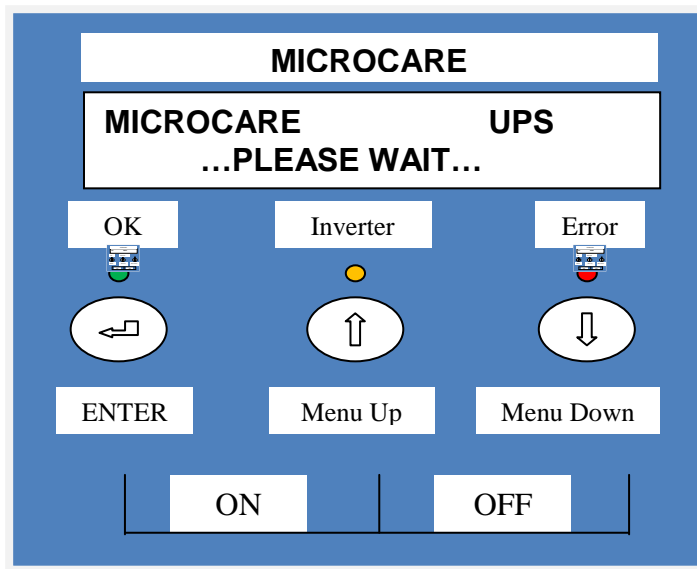

The display then changes to:

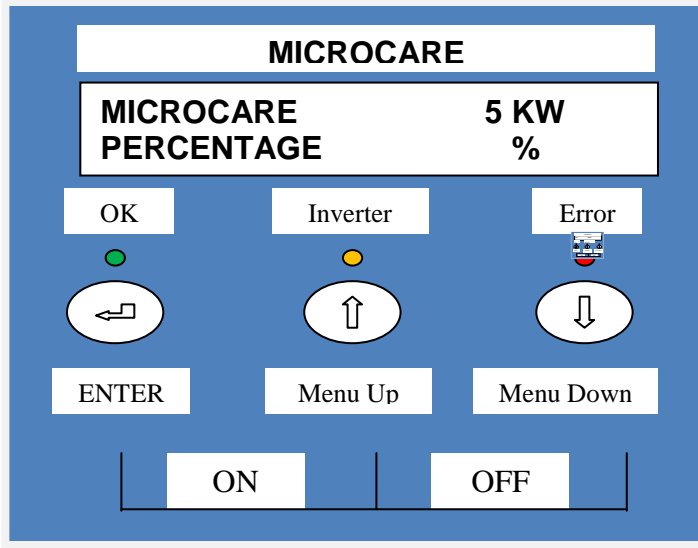

The display then changes to:

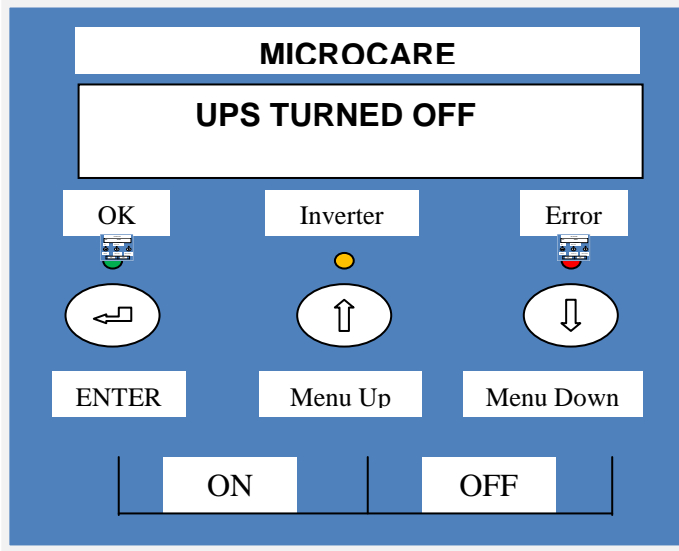

While holding in the **PRECHARGE BUTTON** power on the BATTERY CIRCUIT BREAKER.

Press the ENTER Button for 3 seconds, the INVERTER will confirm the system off status and you will be able to access the setup menu. The display will show:

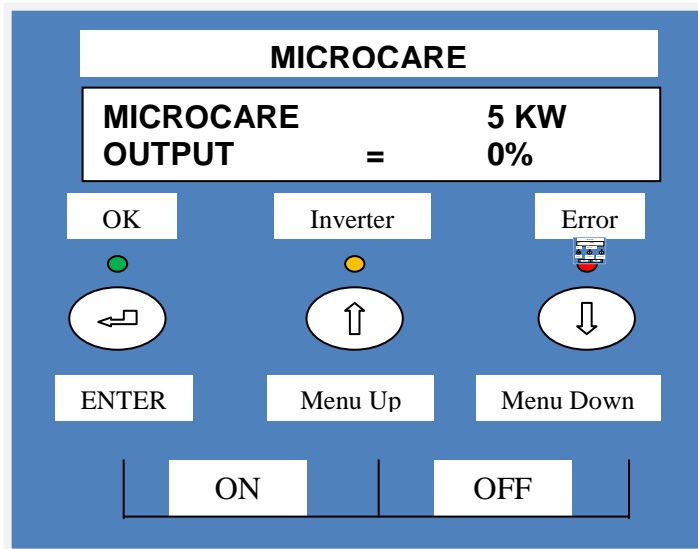

## LCD DISPLAY MENU

Use the Up/Down keys to select menu-displays of the LCD.

Using the **UP/Down** Buttons Go to the SETUP MENU Screen.

### 5.5 Power Down Procedure

5.5.1 Power Off SLAVE PHASE 3 Inverter First.

5.5.2 Power Off SLAVE PHASE 2 Inverter Second.

5.5.3 Power Off MASTER PHASE 1 Inverter Last.

Do the following for all 3 Inverters:

Push and hold the MENU UP and MENU DOWN buttons until the Display shows the following:

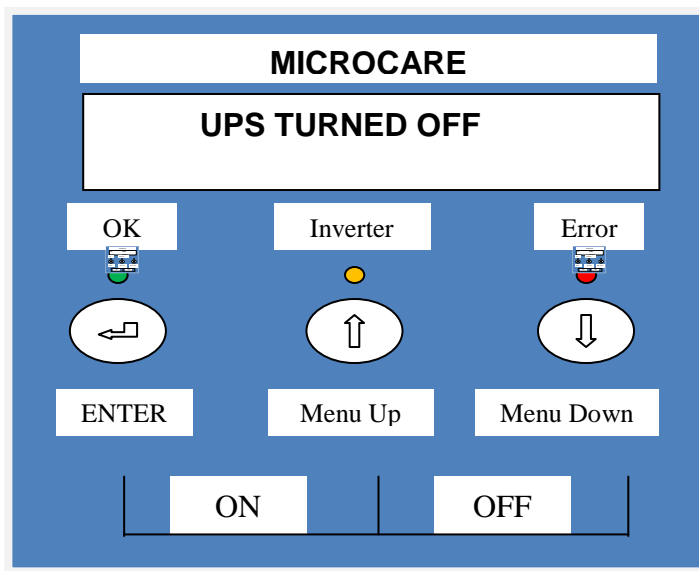

Switch off the Battery Circuit Breakers and wait for the LCD Displays to switch off.

**If the MASTER Inverter is powered off first then the SLAVE Inverters will display an Inverter Cluster Error.**

**Push the ENTER Button to accept the Error and Turn off the Inverters.**

## 6. INVERTER CLUSTER PROGRAMMING

Enter The SETUP Menu:

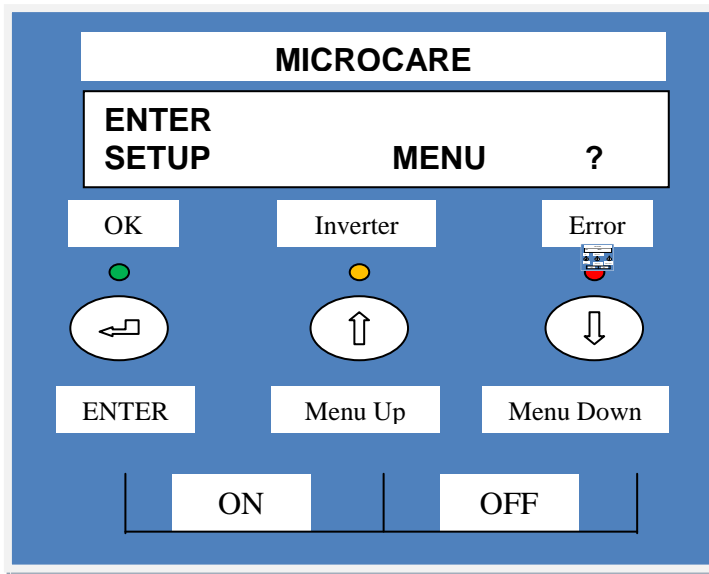

Push ENTER if you want to change the set up menu.

Maintain the Inverter in Manual Mode, Do not change the mode:

Push the UP Button, MENU Changes to:

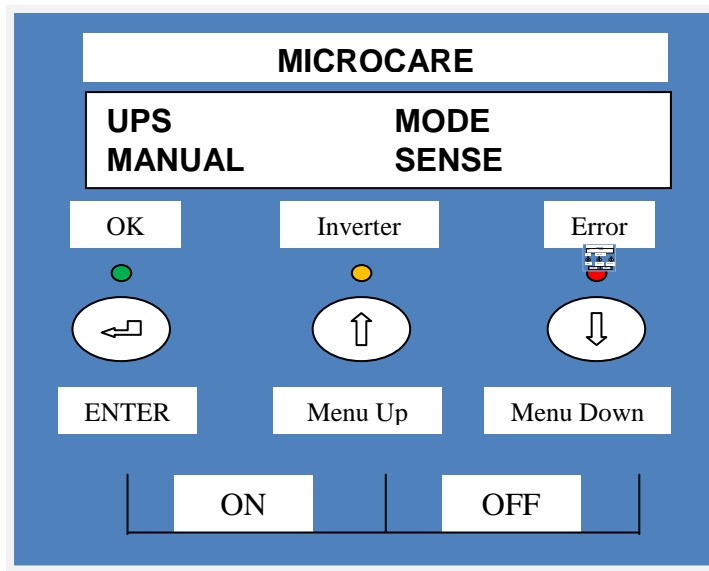

**ALWAYS ENSURE THAT THERE IS 1 INVERTER SETUP AS MASTER.  
PROGRAM THE MASTER INVERTER FIRST.  
ONCE AN INVERTER IS PROGRAMMED TO SLAVE IT CANNOT BE CHANGED.**

**THE MASTER INVERTER WILL ALLOW SETTING CHANGES TO BE PASSED TO THE SLAVE  
INVERTERS**

Push the UP Button, MENU Changes to:

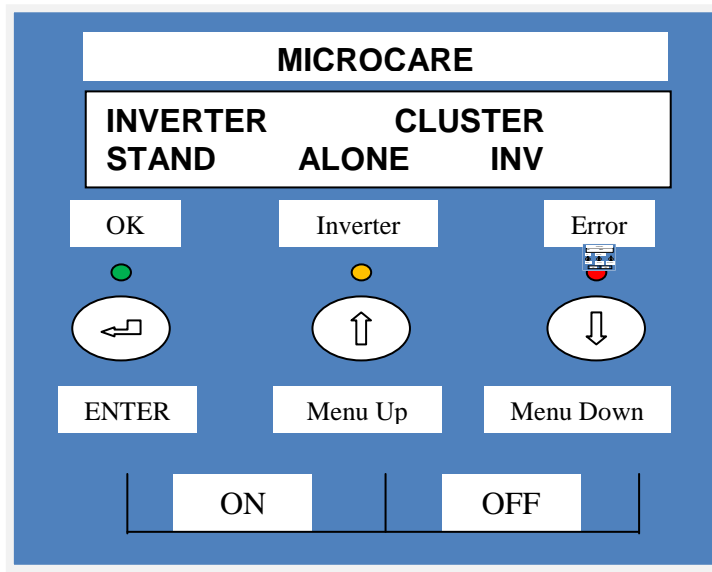

Push the ENTER Button to select the different settings for the 3 Phase Solution:

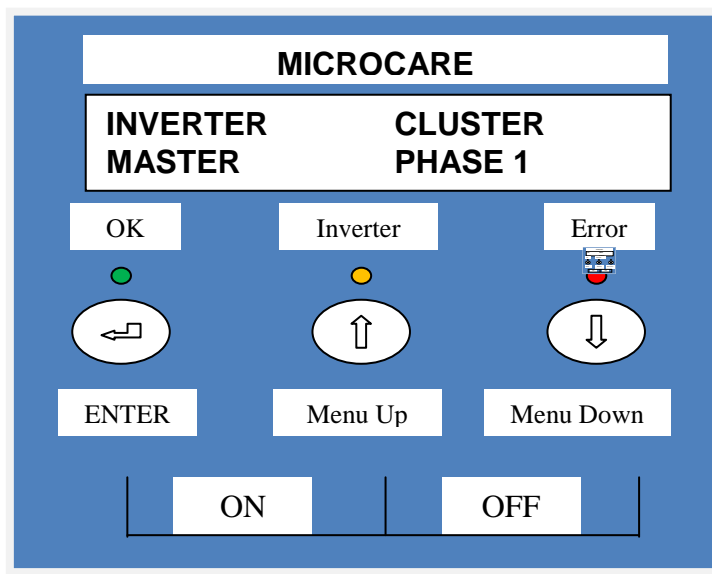

The PHASE 1 Primary Inverter must be set to MASTER. The MASTER unit allows control of the SLAVE units once the setup is complete.

**(If different size inverters are being used for the 3 Phase Cluster Solution then the suggestion is, to place the largest inverter on PHASE 1 as MASTER)**

Push the ENTER Button to select the different settings for the 3 Phase Solution:

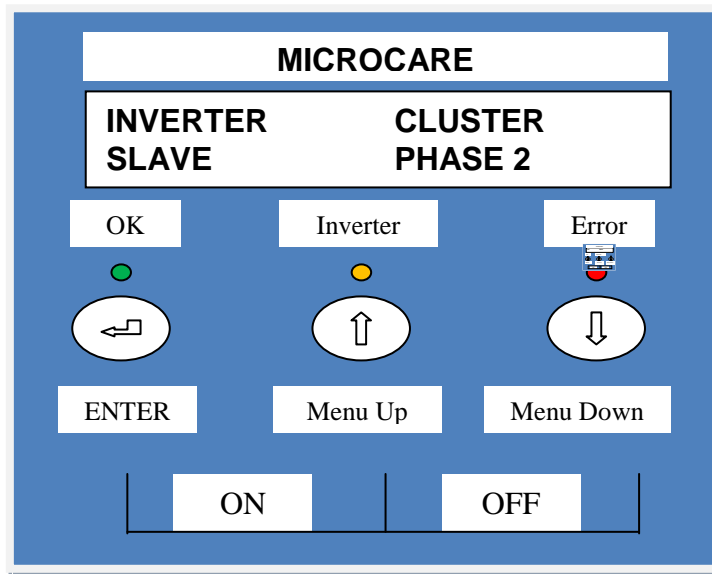

The second Inverter in the cluster needs to be changed to SLAVE PHASE 2

Push the ENTER Button to select the different settings for the 3 Phase Solution:

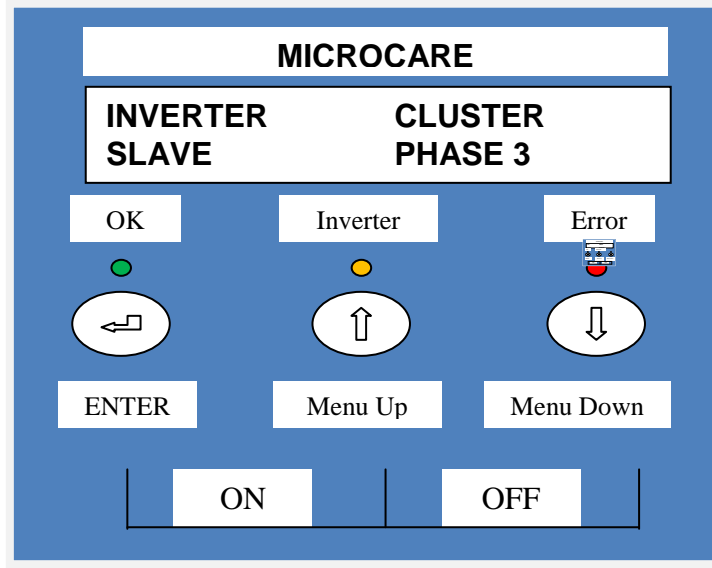

The third Inverter in the cluster needs to be changed to SLAVE PHASE 3

**For a 3 Phase Cluster Solution Microcare would suggest leaving all other settings as the factory default settings.**



Pushing the UP button will give you 3 options to SAVE the changed data. The display will show:

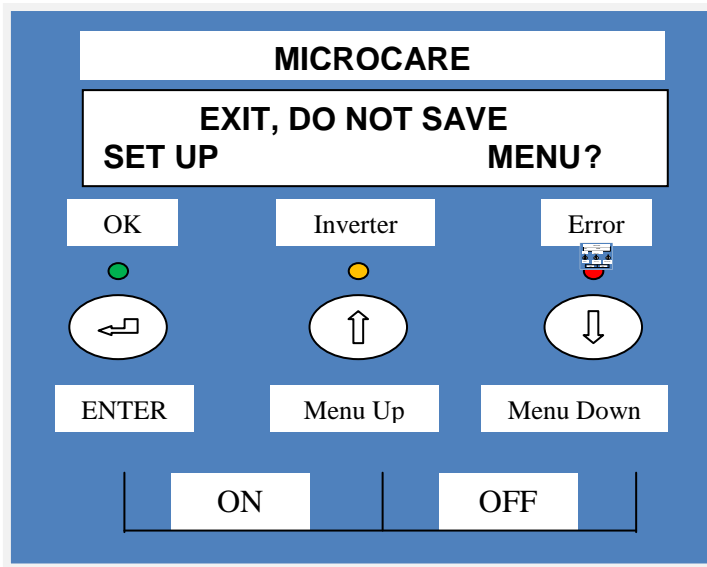
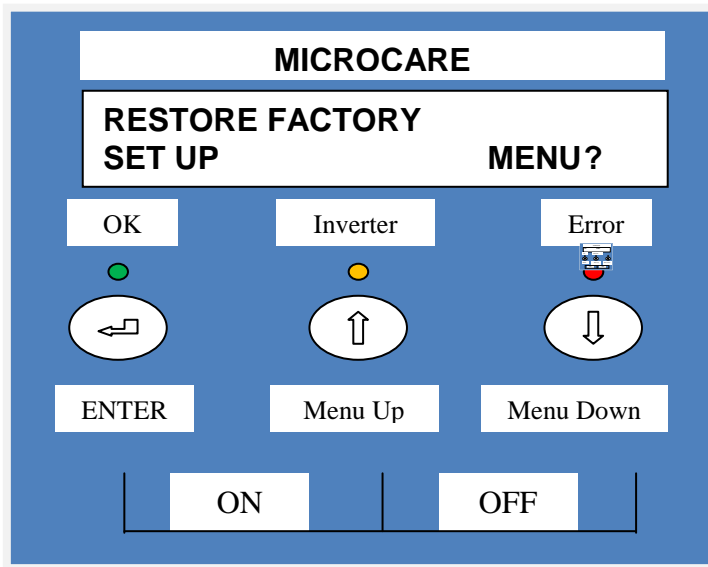
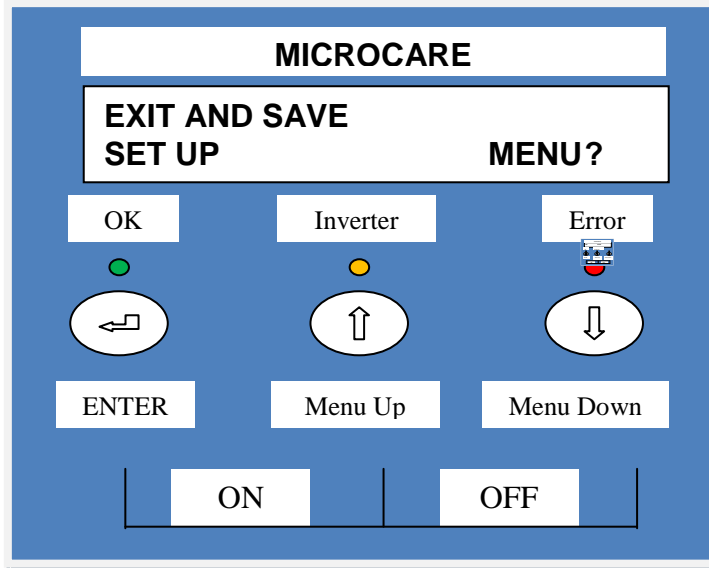

If the changes to the settings need to be saved push ENTER if the enter button is pushed for any of the above then the unit will show:

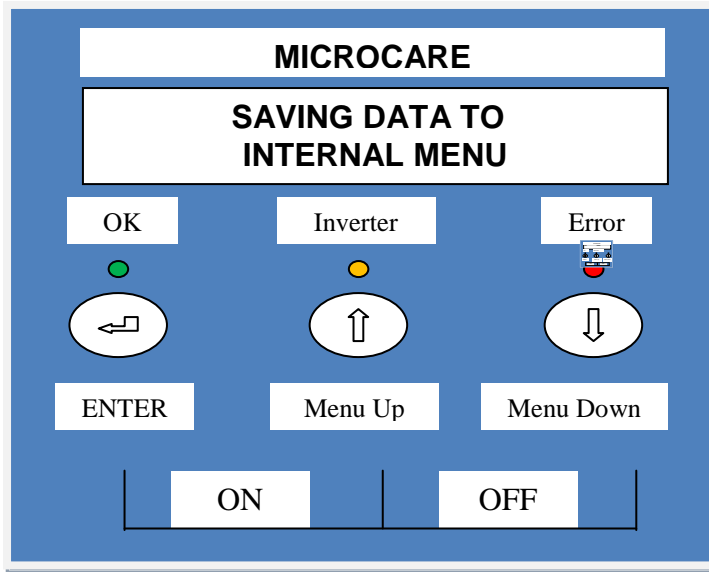

If no entry is made for 1 minute the display will return to the main menu and the back light will turn off.

## 7. CLUSTER SETUP

- 7.1. Confirm No load Output is Connected to the Inverters.
- 7.2. Confirm Grid Power is turned off at the breakers.
- 7.3. Confirm Cluster Communication Cables are connected to the Inverters.

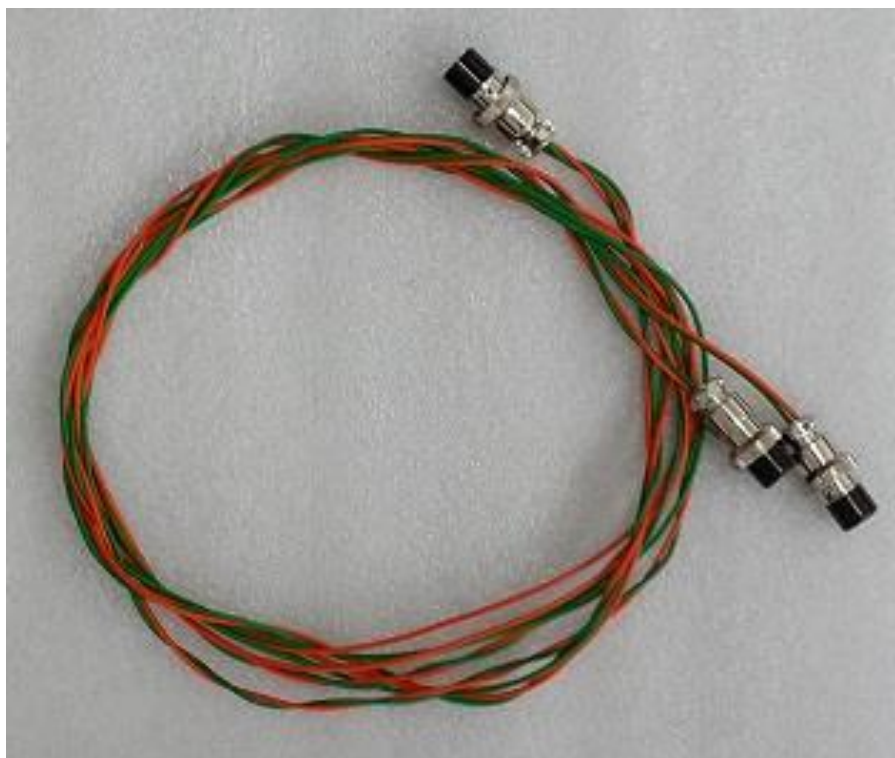

7.4. Confirm that the inverters have been setup to:

7.4.1. MASTER PHASE 1

7.4.2. SLAVE PHASE 2

7.4.3. SLAVE PHASE 3

7.5. Power off all Inverter Battery Breakers and wait until the display on the Inverters has powered down.

7.6. Plug in the Cluster Communication Cables to the Inverters.



7.7. Power up the Inverters as per STEP 5.3.

7.8. Confirm that no errors are displayed on the inverters.

**Check for Cluster or Communication Errors.**

**ERRORS will be displayed on the SLAVE Inverters Only.**

**If there are errors then the following needs to be checked – Cluster Communication Cables not installed correctly or the SLAVE Inverters have not been programmed correctly.**

7.9. If there are no errors displayed on the inverters, then the Inverter Cluster can be turned on by holding the OK and UP buttons on the MASTER Inverter.

7.10. Connect Phase Rotation Indicator to LIVE OUT connection on the inverters.



- 7.10.1. Confirm Phase 1 on meter is connected to MASTER PHASE 1 Inverter.
- 7.10.2. Confirm Phase 2 on meter is connected to SLAVE PHASE 2 Inverter.
- 7.10.3. Confirm Phase 3 on meter is connected to SLAVE PHASE 3 Inverter.

7.11. Confirm the Phase Rotation is to the right.



If the PHASE Rotation is not to the RIGHT, Confirm the meter connections if this does not correct the problem then confirm the Inverter Settings.

- 7.12. If Phase Rotation is to the RIGHT, Power Down the Inverter Cluster as per Step 5.4.
- 7.13. Turn on the 3 Phase GRID Power at the Circuit Breaker.
- 7.14 Connect Phase Rotation Indicator to LIVE IN Connection on the Inverters.
- 7.14.1. Confirm Phase 1 on meter is connected to MASTER PHASE 1 Inverter.
  - 7.14.2. Confirm Phase 2 on meter is connected to SLAVE PHASE 2 Inverter.
  - 7.14.3. Confirm Phase 3 on meter is connected to SLAVE PHASE 3 Inverter.
- 7.15. Confirm the phase rotation is to the right for the LIVE IN Connections as well.



- 7.16. If the Phase rotation is not to the right:
- 7.15.1. Turn Off the Grid Breaker.
  - 7.15.2. Switch the LIVE IN Input for Inverters 2 and 3.
  - 7.15.3. Test Again and confirm Phase rotation to the RIGHT.
- 7.17. When Phase rotation has been confirmed for all options then the inverters can be used to run the 3 Phase Load.
- 7.18. The MASTER inverter will be used to STOP and START the Phase Cluster.

## **J&J ELECTRONICS LIMITED WARRANTY**

J&J Electronics warrants its full range of products against defects in workmanship and materials, fair wear and tear accepted, for a period of three (3) years from the date of delivery/collection for all equipment and are based on a bring-in-basis. Where the installation of the product makes it impractical to bring-in to our workshops, J&J Electronics reserves the right to charge for travel time and kilometres travelled to and from the site where the product is installed.

During this warranty year period, J&J Electronics will, at its own discretion, repair or replace the defective product free of charge. This warranty will be considered void if the unit has suffered any physical damage or alteration, either internally or externally, and does not cover damages arising from improper use such as, but not exclusive to:

- Reverse of battery polarity.
- Inadequate or incorrect connection of the product and/or of its accessories.
- Mechanical shock or deformation.
- Contact with liquid or oxidation by condensation.
- Use in an inappropriate environment (dust, corrosive vapour, humidity, high temperature, biological infestation).
- Breakage or damage due to lightning, surges, spikes or other electrical events.
- Connection terminals and screws destroyed or other damage such as overheating due to insufficient tightening of terminals.
- When considering any electronic breakage except due to lightning, reverse polarity, over-voltage, etc. the state of the internal control circuitry determines the warranty.

This warranty will not apply where the product has been misused, neglected, improperly installed, or repaired by anyone else than J&J Electronics or one of its authorised Qualified Service Partners. In order to qualify for the warranty, the product must not be disassembled or modified. Repair or replacement are our sole remedies and J&J Electronics shall not be liable for damages, whether direct, incidental, special, or consequential, even caused by negligence or fault. J&J Electronics owns all parts removed from repaired products. J&J Electronics uses new or re-conditioned parts made by various manufacturers in performing warranty repairs and building replacement products. If J&J Electronics repairs or replaces a part of a product, its warranty term is not extended. Removal of serial nos. may void the warranty.

All remedies and the measure for damages are limited to the above. J&J Electronics shall in no event be liable for consequential, incidental, contingent or special damages, even if having been advised of the probability of such damages. Any and all other warranties expressed or implied arising by law, course of dealing, course of performance, usage of trade or otherwise, including but not limited to implied warranties of merchantability and fitness for a particular purpose, are limited in duration to a period of three (3) years from the date of purchase.

**Life Support Policy:**

As a general policy, J&J Electronics does not recommend the use of any of its products in life support applications where failure or malfunction of the J&J Electronics product can be reasonably expected to cause failure of the life support device or to significantly affect its safety or effectiveness. J&J Electronics does not recommend the use of any of its products indirect patient care. J&J Electronics will not knowingly sell its products for use in such applications unless it receives in writing assurances satisfactory to J&J Electronics that the risks of injury or damage have been minimised, the customer assumes all such risks, and the Liability of J&J Electronics is adequately protected under the circumstances.

**Caution:**

Our products are sensitive. While all care is taken by us to dispatch goods with adequate packaging, J&J Electronics is not responsible for any damaged caused to products after they have left our premises. Semi-sealed batteries have to be transported upright and must not be put on their side. Please ensure that your transport company or delivery team is aware of the sensitivity of the products they are collecting.

**Goods return policy:**

The following terms apply to returns of items purchased from J&J Electronics, and we require the following information:

1. Details of the item(s) you would like to return.
2. Our invoice number.
3. The reason for the return.
4. J&J Electronics must be notified within 7 days of your intention to return the goods which were purchased.
5. All items returned will be inspected prior to refund. If our technicians are not immediately available, the goods will have to be left with us until such time as a technician is available to check the items.
6. Proof of purchase is required for all returns.
7. The price paid by the customers is the price on which the refund is based.
8. Items purchased can be returned for a refund, replacement or exchange, provided proof of purchase is provided and subject to all other conditions as set down here.
9. All returns may be subject to an administration and handling fee of 10% of purchase price plus VAT.
10. Returns are based on a bring-in basis.
11. Returns will be refused in the following circumstances:
  - a. Where an item has been tampered with, altered or damaged in any way, or
  - b. Where a return is deemed unreasonable, this will be referred to management.

**Severability:**

If a part of the terms and conditions set out above is held invalid, void, or unenforceable due to any particular national or international legislation, it shall not affect other parts of the terms and conditions remaining.

---