

Multi Mono Specialised



*Module images for representation purpose only

Solar PV Module DESERV 3M6 or 3M6H

60 Cells: 260 Wp - 275 Wp
72 Cells: 315 Wp - 335 Wp

The ideal PV Module for all applications that use the highest quality of PV Cells, in-house Encapsulants, and Backsheets.

*60 cells (250 Wp, 255 Wp), 72 cells (300 Wp, 305 Wp, 310 Wp) available on request

Certifications:

- IEC Certified: 61215, 61730
- IEC TS 62804, 61853
- IEC 61701
- IEC 62716
- IEC 60068-2-68
- CAN/CSA: 61730
- UL Certified 1703
- DEWA Listed
- BIS Number R-63000760
- MCS Approved
- Independently audited by SOLARBUYER
- IMS Certified Company - ISO 9001: 2015 & OHSAS 18001:2007
- EMS - ISO 14001: 2015



RenewSys is the first integrated manufacturer of Solar PV Modules and its key components- Encapsulants (EVA and POE), Backsheets and Solar PV Cells. We have a global presence with offices in India, Mauritius, Nigeria, South Africa, Singapore, UAE, China, representatives in Europe, USA, Mexico, and an evolving distributor network.

Registered Office

98, Jolly Maker Chambers No.2,
225 Nariman Point,
Mumbai - 400 021,
Maharashtra, India





Factory

Plot No.6, Survey # 114/P,
Srinagar Village, Maheshwaram
Mandal, Dist - Rangareddy,
Hyderabad - 501 359, Telangana, India

- Please refer to the installation manual for detailed information.





SAFE

-  IP67 Junction box
-  10 years of product warranty
-  25 Years of limited power output warranty
-  1000 Vdc or 1500 Vdc





RELIABLE

-  Extreme weather resilience
-  Windspeed - 2400 Pa, Snowload - 5400 Pa
-  Highly reliable anti-reflective coated glass



HIGH PERFORMANCE

-  PID resistant
-  Low light performance
-  High power density

Ideal for:



Residential



Commercial



Utility



Off-grid

	60 Cells				72 Cells				
DESERV 3M6 or 3M6H (Wp)	260	265	270	275	315	320	325	330	335
Rated power (Pmax), Wp	260	265	270	275	315	320	325	330	335
Max. power voltage (Vmp), V	30.72	30.77	30.95	31.16	36.92	37.20	37.41	37.67	37.90
Max. power current (Imp), A	08.48	08.64	08.74	08.84	08.56	08.62	08.70	08.79	08.85
Open circuit voltage (Voc), V	38.40	38.46	38.70	38.97	46.15	46.18	46.21	46.24	46.27
Short circuit current (Isc), A	08.83	09.00	09.13	09.14	08.92	09.07	09.19	09.31	09.41
Module efficiency (%)	16.00	16.30	16.61	16.92	16.25	16.50	16.76	17.02	17.28
NOCT (Wp) at 45 ±2 °C @800 W/m²	260	265	270	275	315	320	325	330	335
Pmax (W)	193.50	197.22	200.94	204.66	234.43	238.15	241.87	245.59	249.31
Max. power voltage (Vmp), V	28.09	28.14	28.30	28.49	33.76	34.02	34.21	34.45	34.66
Max. power current (Imp), A	06.90	07.03	07.11	07.19	06.97	07.01	07.08	07.15	07.20
Open circuit voltage (Voc), V	35.70	35.76	35.98	36.23	42.91	42.93	42.96	42.99	43.02
Short circuit current (Isc), A	07.21	07.35	07.46	07.47	07.29	07.41	07.51	07.60	07.69

Mechanical Characteristics	60 & 72
Cable	No. 12 AWG, 4mm ² , (1.2m Standard)
PV Connectors	MC4 Compatible (MC4/TYCO on request)
Frame	Anodized Aluminum Alloy
Junction box	IP67 Junction box with 4 rail (3 bypass diodes of 15 A)
Glass	3.2mm Thick low iron tempered (4mm available on request)

Operating Conditions	60 & 72
Ambient temperature, °C	-40 to +85
Max. system voltage, Vdc	1000 or 1500
Hail impact velocity, m/sec	23
Max. surface load capacity, Pa	5400
Max. wind speed capacity, Pa	2400

Cell Temperature Coefficient	60 & 72
Open circuit voltage	-0.30 % / °C
Short circuit current	+0.05 % / °C
Nominal power	-0.40 % / °C

Physical Parameters	260 Wp - 275 Wp	315 Wp - 335 Wp
No. of cells	60	72
Module dimension (mm)	1643 X 989 (± 2)	1960 X 989 (± 2)
Module thickness (mm)	40	40
Approximate weight (kg)	18	21.5
Packaging Configuration - 3M6	60	72
No. of Modules/pallet	26	26

Module Dimension Diagrams (mm)

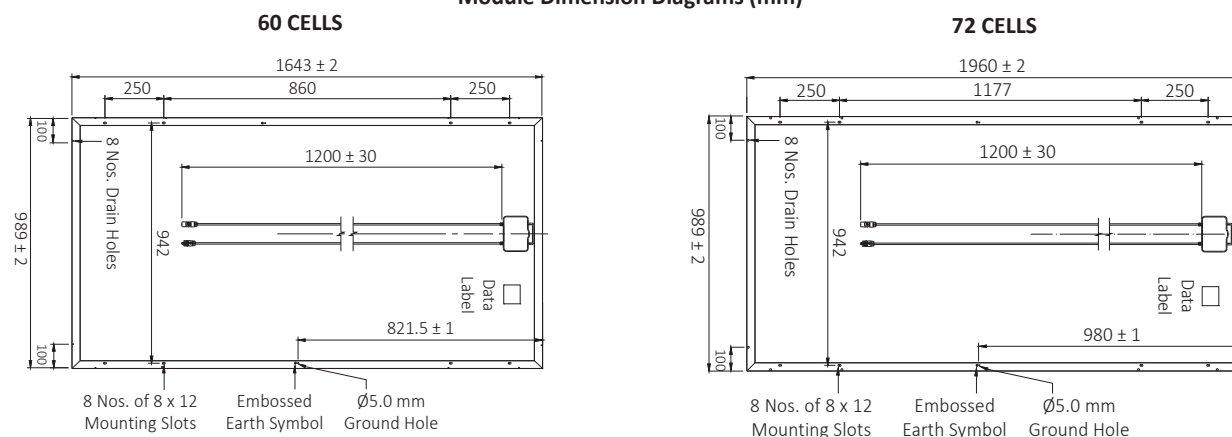

*Due to continuous product updation, specifications may change without notice. Kindly refer to the website for latest information: www.renewsysworld.com