

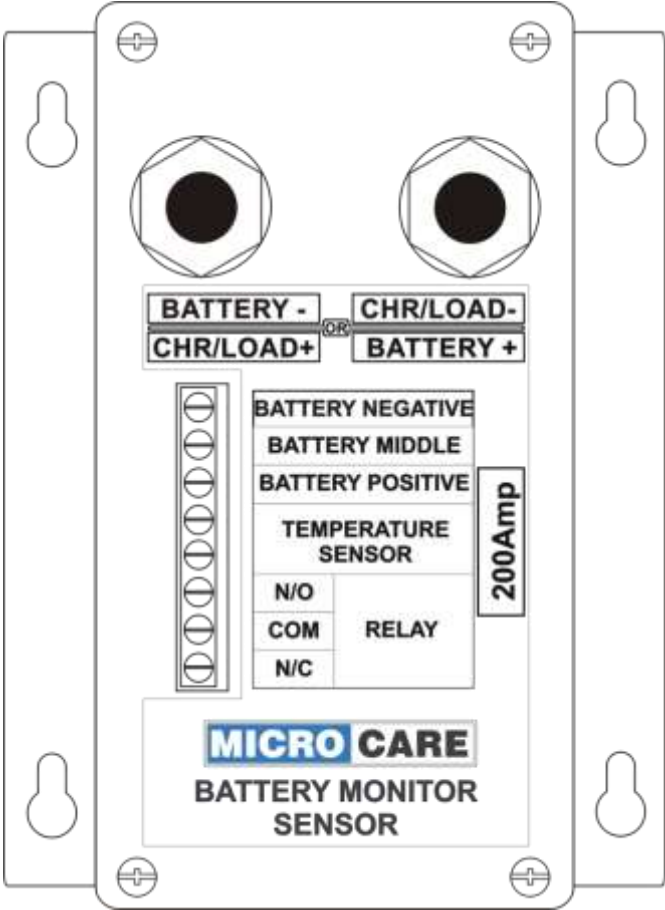

# BATTERY SENSOR

## User Manual



## Table of Contents

1.	IMPORTANT INFORMATION AND SAFETY INSTRUCTIONS .....	2
2.	INTRODUCTION .....	2
2.1	General Description .....	2
3.	OVERVIEW .....	3
3.1	Battery Sensor .....	3
3.2	DIP SWITCH SETTINGS .....	3
4.	BASIC WIRING DIAGRAM SENSOR .....	4
4.1	Sensor <i>connected</i> on the negative battery line. ....	4
4.2	Sensor <i>connected</i> on the positive battery line.....	5
5.	SETUP – SENSOR – ADDRESS .....	6
5.1	Setup – Battery Monitor Sensor – Size .....	7
6.	SETUP – RELAY OUTPUT – MODE.....	8
6.1	Setup – Output – Relay (If “VOLT” is selected).....	9
6.2	Setup – Output – Relay (If “SOC” (State of Charge) is selected) .....	10
6.3	Setup – Output – Relay (If “TOD” (Time of Day) is selected) .....	11
6.4	Setup – Output – Relay (If “TTG” (Time to Go) is selected).....	12
7.	BATTERY SENSOR SPECIFICATIONS .....	13
8.	DESTRIER ELECTRONICS LIMITED CARRY- IN WARRANTY .....	14
9.	REGISTRATION OF MY MICROCARE PRODUCT .....	15

# 1. IMPORTANT INFORMATION AND SAFETY INSTRUCTIONS

This manual applies for the following:

200A Battery Monitor Sensor – Serial number: 2BMS0106C onwards

400A Battery Monitor Sensor – Serial number: 2BMS0036B onwards

- Installers should be qualified electricians or technicians
- The installation information in the manual is for information purposes only.
- Read the instructions carefully before installing and operating the battery sensor.
- Connection and installation instructions must be followed.
- The unit should only be opened by skilled personal.
- To reduce risk of electric shock, disconnect all wiring before making any attempt to maintain or cleaning the unit.
- Retain the load within the rating to prevent faults.
- Sketches are intended for illustrative purposes only and are not intended to provide an electrical design.



## **WARNING**

### **HIGH VOLTAGES PRESENT**

**Voltages capable of causing severe injury or death by electrical shock are present in this unit.**

## 2. INTRODUCTION

### 2.1 General Description

- The Battery Sensor can only be used in conjunction with the Microcare Battery Monitor.
- Max of 4 Battery Sensors per Battery Monitor.

### 3. OVERVIEW

#### 3.1 Battery Sensor

Figure 3-1

**Please Note: DO NOT LOOSEN THIS NUT**

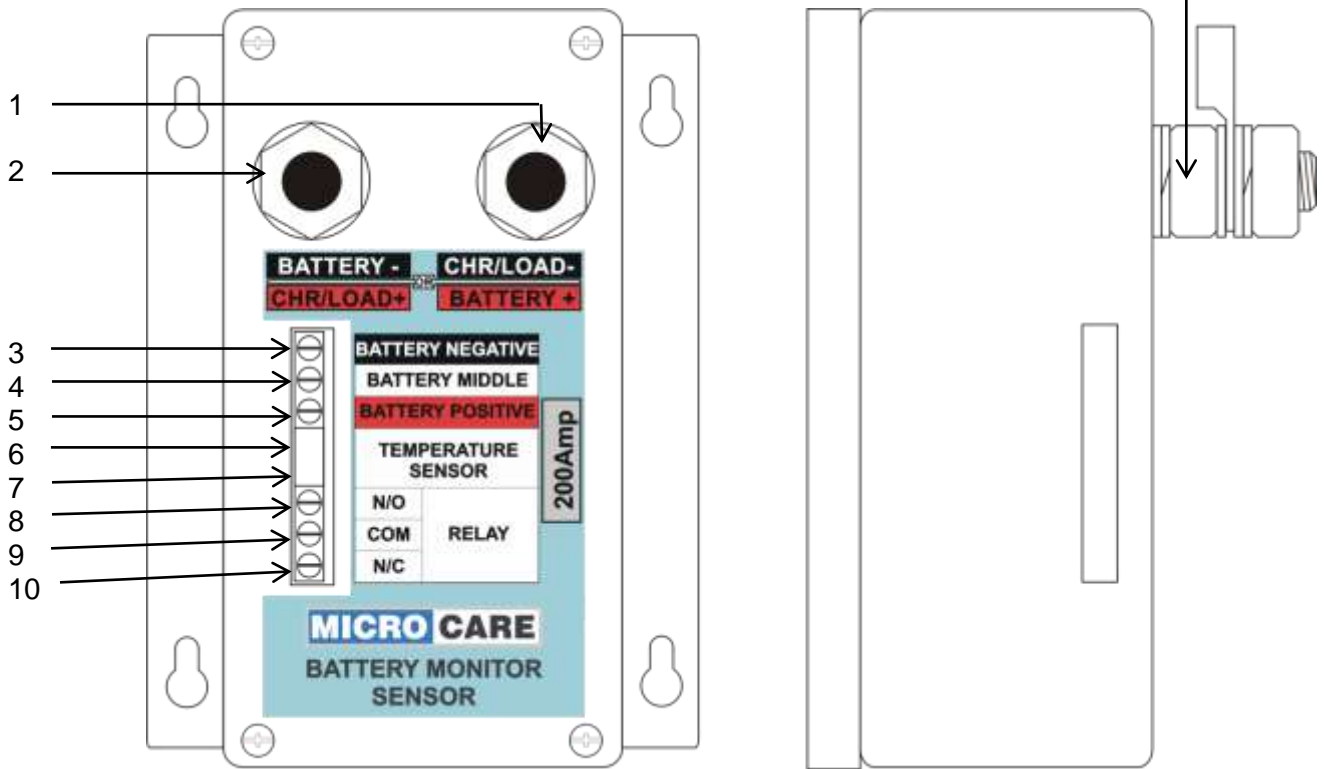

Battery Sensor Side View

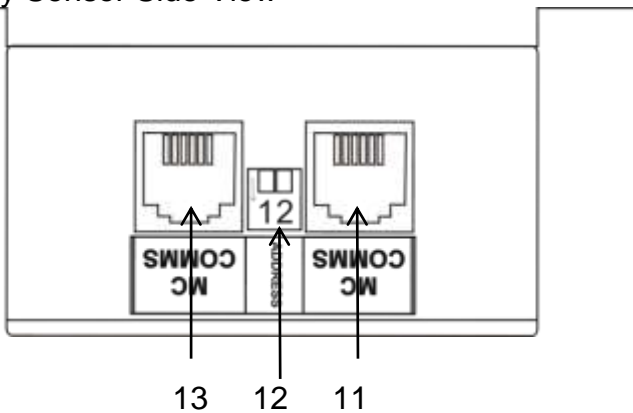

#### 3.2 DIP SWITCH SETTINGS

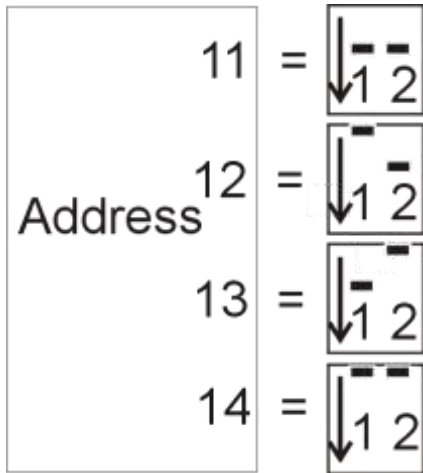

No	Description
1	Battery Positive or Charge/Load Negative
2	Battery Negative or Charge/ Load Positive
3	Battery Negative Sensing Wire
4	Battery Midpoint Sensing Wire
5	Battery Positive Sensing Wire
6+7	Temperature Sensor
8	Relay Normally Open
9	Relay Common
10	Relay Normally Closed
11	MC Comms
12	DIP Switches
13	MC Comms

4. BASIC WIRING DIAGRAM SENSOR  
 4.1 Sensor connected on the negative battery line.

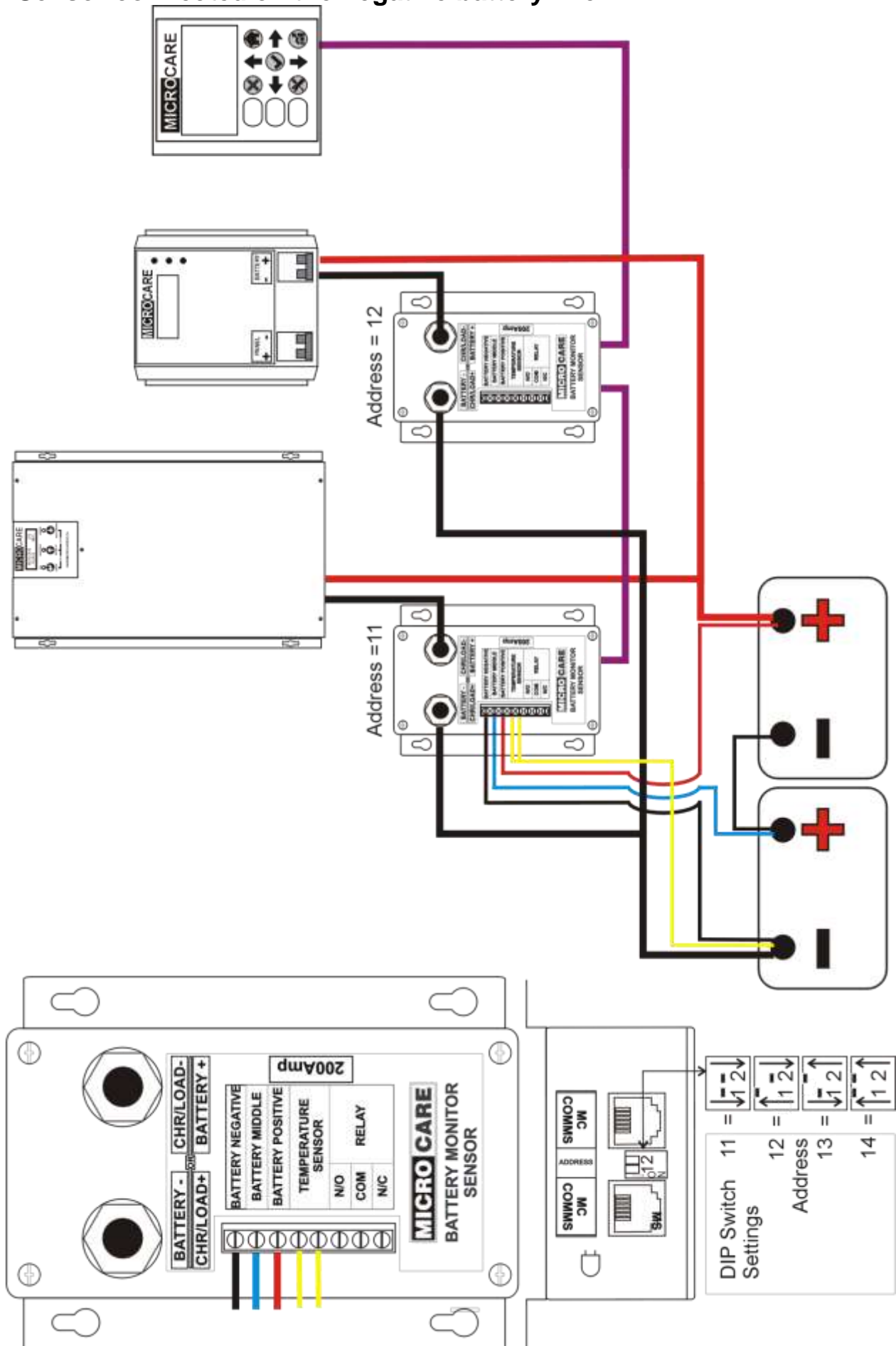

4.2 Sensor connected on the positive battery line

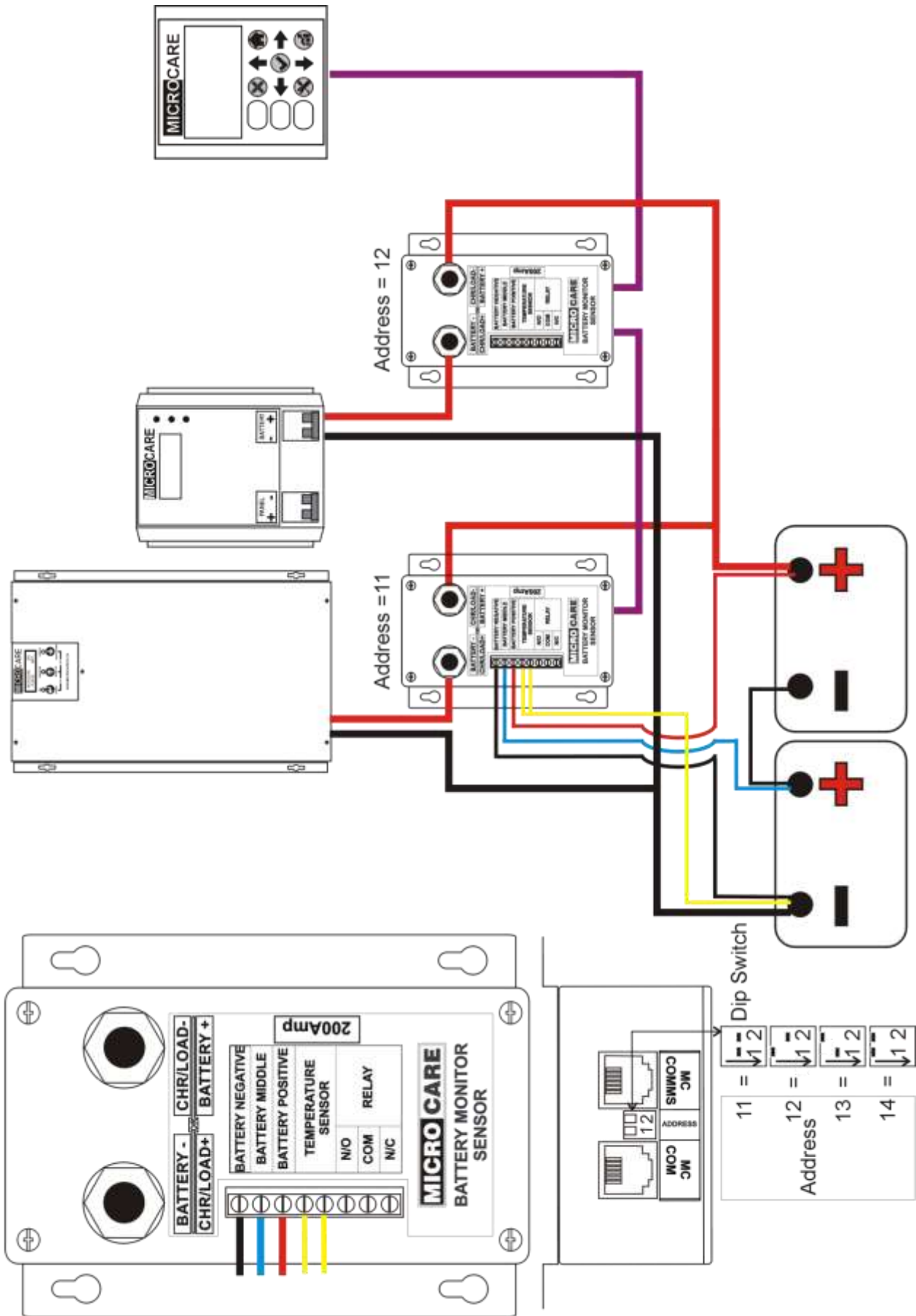

## 5. SETUP – SENSOR – ADDRESS

Setup the sensor address on the Battery Sensor as per the DIP switches on the previous page.

### *Programming the Battery Monitor*

How to enter “Battery Monitor Setup – Sensor – Address” menu:

To allow the user to set the address of the sensor modules connected to the battery monitor.

Take Note: The address is provided on the battery monitor sensor.

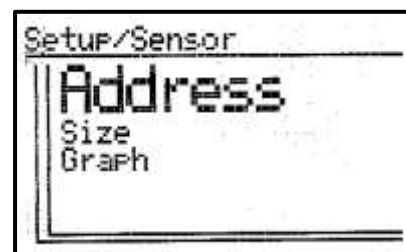
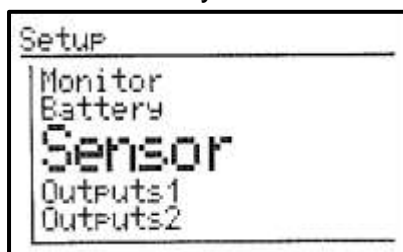
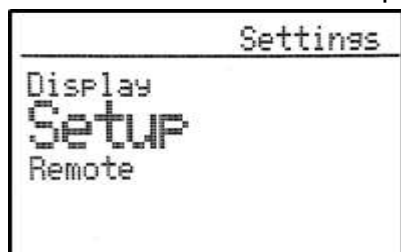

1. Press **X** from the “Home” screen to enter the “Settings” screen.
2. In “Settings”, press **↑** or **↓** to highlight “Setup” and press **✓**.
3. In “Setup” sub-menu, press **↑** or **↓** to highlight “Sensor” and press **✓**.
4. In “Sensor” sub-menu, press **↑** or **↓** to highlight “Address” and press **✓**.

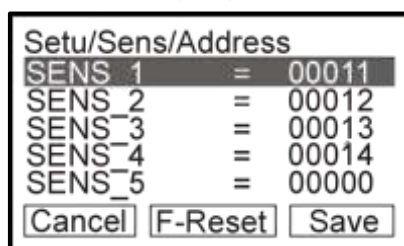

How to change the address of sensor 1 to 4:

5. In “Setu/Sens/Address”, press **↑** or **↓** to choose between highlighting “SENS\_1” to “SENS\_4” and press **✓**, then the value on the right will be highlighted.
6. Press **↑** or **↓** to choose your value.  
**Range:** 00011 = Minimum, 00000 = Default, 00014 = Maximum
7. Press **✓** on your desired selection.

When desired changes have been made:

8. **Save:** Select “Save”, then press **✓** to save changes made.  
**F-Reset:** Select “F-Reset”, then press **✓** to reset that battery monitor to its default.  
**Cancel:** Select “Cancel”, then press **✓** to cancel settings made.

## 5.1 Setup – Battery Monitor Sensor - Size

How to enter the “Setup – Sensor – Size” menu:

To allow the user to set the size of the sensor modules connected to the battery monitor.

Take Note: The size is indicated on the battery monitor sensor.

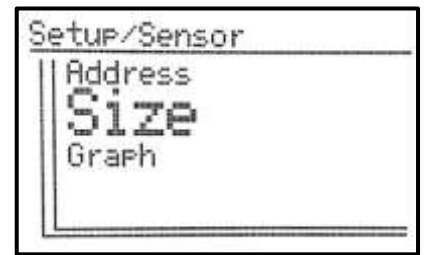

1. Press **X** from the “Home” screen to enter the “Settings” screen.
2. In “Settings”, press **↑** or **↓** to highlight “Setup” and press **✓**.
3. In “Setup” sub-menu, press **↑** or **↓** to highlight “Sensor” and press **✓**.
4. In “Sensor” sub-menu, press **↑** or **↓** to highlight “Size” and press **✓**.

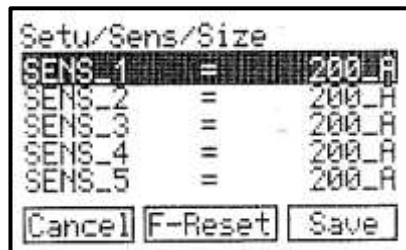

How to set the size of sensor 1 – 4:

5. In “Setu/Sens/Size”, press **↑** or **↓** to choose between highlighting “SENS\_1” to “SENS\_4” and press **✓**, then the value on the right will be highlighted.
6. Press **↑** or **↓** to choose your value in Amps.  
**Range:** 50\_A = Minimum, 200\_A = Default, 400\_A = Maximum
7. Press **✓** on your desired selection.

When desired changes have been made:

8. Save: Select “Save”, then press **✓** to save changes made.
- F-Reset: Select “F-Reset”, then press **✓** to reset that battery monitor to its default.
- Cancel: Select “Cancel”, then press **✓** to cancel settings made.



## 6. SETUP – RELAY OUTPUT – MODE

How to enter the “Setup – Output1/Output 2 – Mode” menu:

To allow the user to set the mode in which the relay modules should function.

If the Battery Sensor selected is programmed as sensor 1, relay 1 form the battery monitor menu must be programmed to set the mode in which the battery sensor relay should function.

If the Battery Sensor selected is programmed as sensor 2, relay 2 form the battery monitor menu must be programmed to set the mode in which the battery sensor relay should function.

“FRC\_ON” (Force On) – The relay will be on permanently.

“FRC\_OFF” (Force Off) – The relay will be off permanently.

“SOC” (State of Charge) – The relay will be controlled by the state of charge (SOC) of the battery.

For Example: When the battery only has 20% remaining, it may turn off.

“VOLT” (Voltage) - The relay will be controlled by the voltage of the battery.

For Example: When the battery reaches 11 Volts, the relay will turn off.

“TOD” (Time of Day” – The relay will be controlled by the time of the day.

For Example: The relay will turn on at 5 o’clock and turn of at 7 o’clock.

“TTG” (Time to Go) – The relay will be controlled by the time to go in the battery.

For Example: The relay will turn off if there is less than 8 hours of run time in the battery.

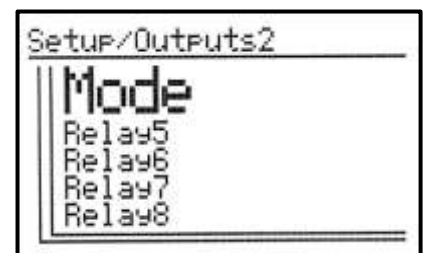
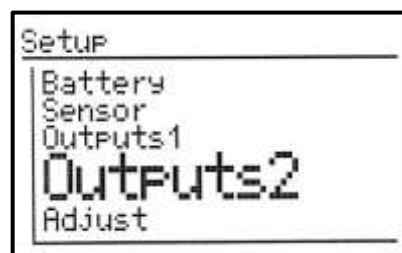
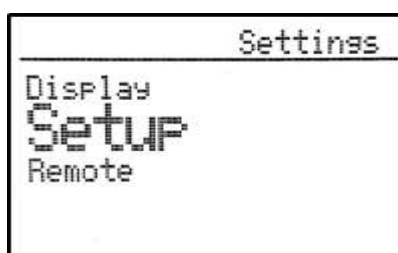
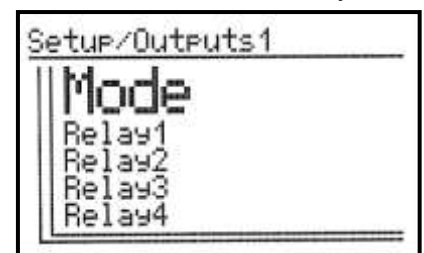
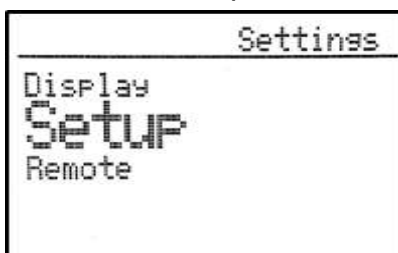

1. Press **X** from the “Home” screen to enter the “Settings” screen.
2. In “Settings”, press **↑** or **↓** to highlight “Setup” and press **✓**.
3. In “Setup” sub-menu, press **↑** or **↓** to highlight the output menu you want, and press **✓**.  
(Output 1 menu for relay 1 – 4 and Output 2 menu for relay 5 - 8)
4. In the “Output” sub-menu, press **↑** or **↓** to highlight “Mode” and press **✓**.

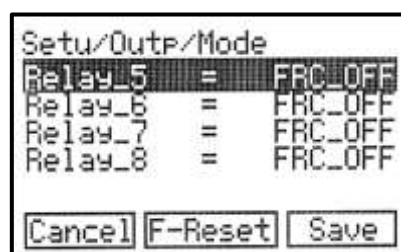
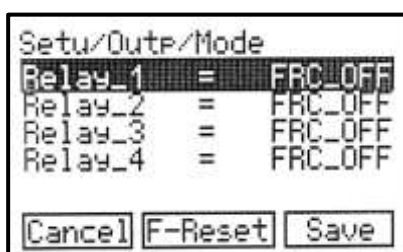

How to choose the mode of relay 1 - 8:

5. In “Setu/Outp/Mode”, press **↑** or **↓** to highlight the relay you wish to change the mode of, and press **✓**, then the option on the right will be highlighted.
6. Press **↑** or **↓** to choose the relay setting.  
**Range:** “SOC”, “FRC\_ON”, “FRC\_OFF”, “TOD”, “TTG” or “VOLT”, “FRC\_OFF = Default
7. Press **✓** on your desired selection.

When desired changes have been made:

8. Save: Select “Save”, then press **✓** to save changes made.
- F-Reset: Select “F-Reset”, then press **✓** to reset that battery monitor to its default.
- Cancel: Select “Cancel”, then press **✓** to cancel settings made.

## 6.1 Setup – Output - Relay (If “VOLT” is selected)

How to enter the “Setup – Output - Relay” menu:

To allow the user to set the operation of the relay, according to the voltage of the battery.

A good recommendation for a non-essential load on a 12V battery would be “Volt\_ON” = 13,8V and “Volt\_OFF” = 11V. In this example, starting with a full battery the load will run until the battery falls below 11V, then the load will be turned off. The load will only turn back on when the battery recovers to above 13,8V.

1. Press **✕** from the “Home” screen to enter the “Settings” screen.
2. In “Settings”, press **↑** or **↓** to highlight “Setup” and press **✓**.
3. In “Setup” sub-menu, press **↑** or **↓** to highlight the output menu you want, and press **✓**.
4. In the “Outputs” sub-menu, press **↑** or **↓** to highlight the “Relay” you want, and press **✓**.

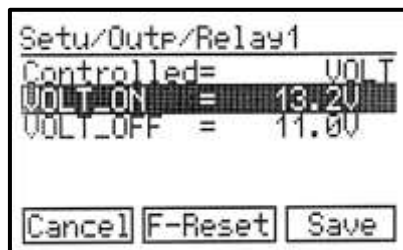

How to set the voltage at which the relay will turn on:

5. In “Setu/Outp/Relay”, press **↑** or **↓** to highlight “VOLT\_ON” and press **✓**, then the value in volts on the right will be highlighted.
6. Press **↑** or **↓** to choose the value in volts.  
**Range:** 48.0V = Minimum, 52.8V = Default, 58.0V = Maximum
7. Press **✓** on your desired selection.

How to set the voltage at which the relay will turn off:

5. In “Setu/Outp/Relay”, press **↑** or **↓** to highlight “VOLT\_OFF” and press **✓**, then the value in volts on the right will be highlighted.
6. Press **↑** or **↓** to choose your value in volts.  
**Range:** 40V = Minimum, 44.0V = Default, 50V = Maximum
7. Press **✓** on your desired selection.

When desired changes have been made:

8. Save: Select “Save”, then press **✓** to save changes made.
- F-Reset: Select “F-Reset”, then press **✓** to reset that battery monitor to its default.
- Cancel: Select “Cancel”, then press **✓** to cancel settings made.

## 6.2 Setup – Output – Relay (If “SOC” (State of Charge) is selected)

How to enter the “Setup – Output - Relay” menu:

*To allow the user to set the operation of the relay, according to the state of charge (SOC) of the battery.*

A good recommendation for a non-essential load would be “SOC\_ON” = 90% and “SOC\_OFF” = 40%. In this example, starting with a full battery the load will run until the battery falls below a 40% SOC, then the load will be turned off. The load will only turn back on when the battery recovers to above a 90% SOC.

1. Press **X** from the “Home” screen to enter the “Settings” screen.
2. In “Settings”, press **↑** or **↓** to highlight “Setup” and press **✓**.
3. In “Setup” sub-menu, press **↑** or **↓** to highlight the output menu you want, and press **✓**.
4. In the “Output” sub-menu, press **↑** or **↓** to highlight the relay you want, and press **✓**.

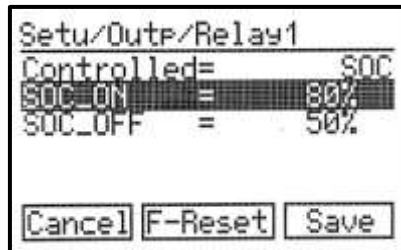

How to set the SOC at which the relay will turn on:

5. In “Setu/Outp/Relay”, press **↑** or **↓** to highlight “SOC\_ON” and press **✓**, then the value in percentage on the right will be highlighted.
6. Press **↑** or **↓** to choose the value in percentage.  
**Range:** 50% = Minimum, 80% = Default, 100% = Maximum
7. Press **✓** on your desired selection.

How to set the SOC at which the relay will turn off:

5. In “Setu/Outp/Relay” press **↑** or **↓** to highlight “SOC\_OFF” and press **✓**, then the value in percentage on the right will be highlighted.
6. Press **↑** or **↓** to choose the value in percentage.  
**Range:** 0% = Minimum, 50% = Default, 80% = Maximum
7. Press **✓** on your desired selection.

When desired changes have been made:

8. Save: Select “Save”, then press **✓** to save changes made.
- F-Reset: Select “F-Reset”, then press **✓** to reset that battery monitor to its default.
- Cancel: Select “Cancel”, then press **✓** to cancel settings made.

### 6.3 Setup – Output – Relay (If “TOD” (Time of Day) is selected)

#### How to enter “Setup – Output – Relay”:

To allow the user to set the operation of the relay according to the time of day.

A good recommendation for a timed load would be “Hour\_ON” = 18, “Min\_ON” = 30, “Hour\_OFF” = 7, “Min\_OFF” = 20. In this example the load will turn on at 18:30 (6:30pm) at night and only turn back off at 7:20 (7:20am) in the morning.

1. Press **X** from the “Home” screen to enter the “Settings” screen.
2. In “Settings”, press **↑** or **↓** to highlight “Setup” and press **✓**.
3. In “Setup” sub-menu, press **↑** or **↓** to highlight the output menu you want, and press **✓**.
4. In the “Outputs” sub-menu, press **↑** or **↓** to highlight the relay you want, and press **✓**.

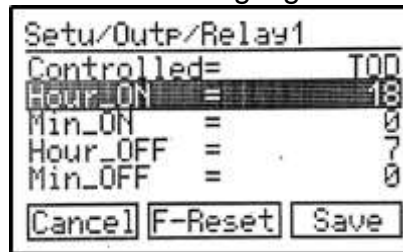

#### How to set the hour to turn on:

5. In “Setu/Outp/Relay”, press **↑** or **↓** to highlight “Hour\_ON” and press **✓**, then the value in hours on the right will be highlighted.
6. Press **↑** or **↓** to enter the value in hours.  
**Range:** 0 = Minimum, 18 = Default, 23 = Maximum
7. Press **✓** on your desired selection.

#### How to set the minute to turn on:

5. In “Setu/Outp/Relay”, press **↑** or **↓** to highlight “Min\_ON” and press **✓**, then the value in minutes on the right will be highlighted.
6. Press **↑** or **↓** buttons to enter the value in minutes.  
**Range:** 0 = Minimum, 0 = Default, 59 = Maximum
7. Press **✓** on your desired selection.

#### How to set the hour to turn off:

5. In “Setu/Outp/Relay”, press **↑** or **↓** to highlight “Hour\_OFF” and press **✓**, then the value in hours on the right will be highlighted.
6. Press **↑** or **↓** to enter the value in hours.  
**Range:** 0 = Minimum, 7 = Default, 23 = Maximum
7. Press **✓** on your desired selection.

#### How to set the minute to off:

5. In “Setu/Outp/Relay”, press **↑** or **↓** to highlight “Min\_OFF” and press **✓**, then the value in minutes on the right will be highlighted.
6. Press **↑** or **↓** to enter the value in minutes.  
**Range:** 0 = Minimum, 0 = Default, 59 = Maximum
7. Press **✓** on your desired selection.

#### When desired changes have been made:

9. Save: Select “Save”, then press **✓** to save changes made.
- F-Reset: Select “F-Reset”, then press **✓** to reset that battery monitor to its default.
- Cancel: Select “Cancel”, then press **✓** to cancel settings made.

## 6.4 Setup – Output – Relay (If “TTG” (Time to Go) is selected)

### How to enter “Setup – Output – Relay”:

To allow the user to set the operation of the relay according to the usable time remaining in the battery.

A good recommendation for a non-essential load would be “Hour\_ON” = 24, “Min\_ON” = 15, “Hour\_OFF” = 8, “Min\_OFF” = 0. In this example, starting with a full battery the load will run until there is less than 8 hours of operation remaining in the battery, the load will then be turned off. The load will only turn back on when the battery recovers to having more than 24hours and 15minutes of operation remaining in it.

1. Press **X** from the “Home” screen to enter the “Settings” screen.
2. In “Settings”, press **↑** or **↓** to highlight “Setup” and press **✓**.
3. In “Setup” sub-menu, press **↑** or **↓** to highlight the output menu you want, and press **✓**.
4. In the “Output” sub-menu, press **↑** or **↓** to highlight the relay you want, and press **✓**.

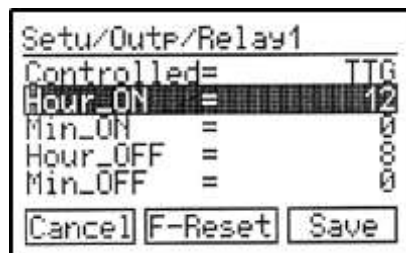

### How to set the hour on:

5. In “Setu/Outp/Relay”, press **↑** or **↓** to highlight “Hour\_ON” and press **✓**, then the value in hours on the right will be highlighted.
6. Press **↑** or **↓** to enter the value in hours.  
**Range:** 0 = Minimum, 12 = Default, 23 = Maximum
7. Press **✓** on your desired selection.

### How to set the minute on:

5. In “Setu/Outp/Relay”, press **↑** or **↓** to highlight “Min\_ON” and press **✓**, then the value in minutes on the right will be highlighted.
6. Press **↑** or **↓** to enter the value in minutes.  
**Range:** 0 = Minimum, 0 = Default, 59 = Maximum
7. Press **✓** on your desired selection.

### How to set the hour off:

5. In “Setu/Outp/Relay”, press **↑** or **↓** to highlight “Hour\_OFF” and press **✓**, then the value in hours on the right will be highlighted.
6. Press **↑** or **↓** to enter the value in hours.  
**Range:** 0 = Minimum, 8 = Default, 23 = Maximum
7. Press **✓** on your desired selection.

### How to set the minute off:

5. In “Setu/Outp/Relay”, press **↑** or **↓** to highlight “Min\_OFF” and press **✓**, then the value in minutes on the right will be highlighted.
6. Press **↑** or **↓** to enter the value in minutes.  
**Range:** 0 = Minimum, 0 = Default, 59 = Maximum
7. Press **✓** on your desired selection.

### When desired changes have been made:

8. **Save:** Select “Save”, then press **✓** to save changes made.
- F-Reset:** Select “F-Reset”, then press **✓** to reset that battery monitor to its factory default settings.

**Cancel:** Select “Cancel”, then press **✓** to cancel settings made

## 7. BATTERY SENSOR SPECIFICATIONS

<b>Model</b>	<b>200A</b>	<b>400A</b>
<b>Max Shunt Current</b>	200A	400A
<b>Output Relay Contact Specs</b>	1A@30VDC, 0,3A@60VDC 0,5A@125VAC, 0,25@250VAC	
<b>Dimensions (HxWxD)</b>	50 x 130 x 100mm	
<b>Warranty</b>	1 year	

## 8. DESTRIER ELECTRONICS LIMITED CARRY- IN WARRANTY

Destrier Electronics warrants the Battery Monitor Sensor against defects in workmanship and materials, fair wear and tear accepted, for a period of 1 (one) year from the date of delivery/collection for all equipment and is based on a carry-in basis. Where the installation of the product makes it impractical to carry-in to our workshops, Destrier Electronics reserves the right to charge for travel time and kilometres travelled to and from the site where the product is installed.

During this warranty period, Destrier Electronics will, at its own discretion, repair or replace the defective product free of charge. This warranty will be considered void if the unit has suffered any physical damage or alteration, either internally or externally, and does not cover damages arising from improper use such as, but not exclusive to:

- Reverse of battery polarity.
- Inadequate or incorrect connection of the product and/or of its accessories.
- Mechanical shock or deformation.
- Contact with liquid or oxidation by condensation.
- Use in an inappropriate environment (dust, corrosive vapour, humidity, high temperature, biological infestation.)
- Breakage or damage due to lightning, surges, spikes or other electrical events.
- Connection terminals and screws destroyed or other damage such as overheating due to insufficient tightening of terminals.
- When considering any electronic breakage except due to lightning, reverse polarity, over-voltage, etc. the state of the internal control circuitry determines the warranty.

This warranty will not apply where the product has been misused, neglected, improperly installed, or repaired by anyone else than Destrier Electronics or one of its authorised Qualified Service Partners. In order to qualify for the warranty, the product must not be disassembled or modified. Repair or replacements are our sole remedies. Destrier Electronics shall not be liable for damages, whether direct, incidental, special, or consequential, even caused by negligence or fault. Destrier Electronics owns all parts removed from repaired products. Destrier Electronics uses new or re-conditioned parts made by various manufacturers in performing warranty repairs and building replacement products. If Destrier Electronics repairs or replaces a part of a product, its warranty term is not extended. Removal of serial nos. may void the warranty.

All remedies and the measure for damages are limited to the above. Destrier Electronics shall in no event be liable for consequential, incidental, contingent or special damages, even if having been advised of the probability of such damages. Any and all other warranties expressed or implied arising by law, course of dealing, course of performance, usage of trade or otherwise, including but not limited to implied warranties of merchantability and fitness for a particular purpose, are limited in duration to a period of 1 (one) year from the date of purchase.

### **Life Support Policy:**

As a general policy, Destrier Electronics does not recommend the use of any of its products in life support applications where failure or malfunction of the Destrier Electronics product can be reasonably expected to cause failure of the life support device or to significantly affect its safety or effectiveness.

Destrier Electronics does not recommend the use of any of its products in direct patient care. Destrier Electronics will not knowingly sell its products for use in such applications unless it receives in writing assurances satisfactory to Destrier Electronics that the risks of injury or damage have been minimised, the customer assumes all such risks, and the Liability of Destrier Electronics is adequately protected under the circumstances.

### **Caution:**

Our products are sensitive. While all care is taken by us to dispatch goods with adequate packaging, Destrier Electronics is not responsible for any damages caused to products after they have left our premises.

## 9. REGISTRATION OF MY MICROCARE PRODUCT

Product Serial Number:

---

Product Description:

---

Date Purchased

---

### Where was the Product Purchased?

Company Name

---

Contact Person

---

Contact Number

---

E-mail Address

---

### Installation Company Information:

Company Name

---

Contact Person

---

Contact Number

---

E-mail Address

---

### Details of Product Owner

Name & Surname

---

Address

---

City & Province

---

Contact Number

---

E-mail Address

---

Date Installed

---

Microcare: 1<sup>st</sup> Floor, Neave Industrial Park, Korsten, Port Elizabeth  
P.O.Box 7227, Newton Park, 6055  
Tel: 041 453 5761, Fax: 041 – 453 5763  
Technical Support e-mail: [support@microcare.co.za](mailto:support@microcare.co.za)  
Website: [www.microcare.co.za](http://www.microcare.co.za)

Registration by fax:

041 – 453 5763

Registration by e-mail:

[support@microcare.co.za](mailto:support@microcare.co.za)

Online Registration:

[www.microcare.co.za/register-my-product](http://www.microcare.co.za/register-my-product)